

DATA SHEET - OPERATION MANUAL

APPLICATION

Electrically operated directional spool valve type **WE10...P** is intended for changing the direction of fluid flow in a hydraulic system allowing change of the direction of movement of the receiver – usually a piston rod of a cylinder or a hydraulic motor and also performance of states: *start, stop*. It can be used to eliminate arising when overriding adverse dynamic phenomena as a less expensive alternative to proportionally controlled directional control valve with electronic controller. It is adjusted for subplate mounting in any position.

Directional spool valve is complied with the regulations of directive **2006/95/WE** for the following voltages:

- 50 – 250 V for AC
- 75 – 250 V for DC

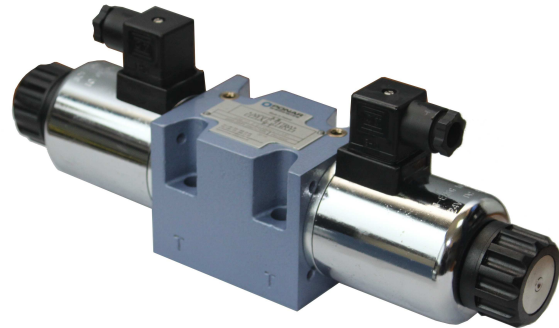

DESCRIPTION OF OPERATION

4WE10 E - 62/G24NZ4 P

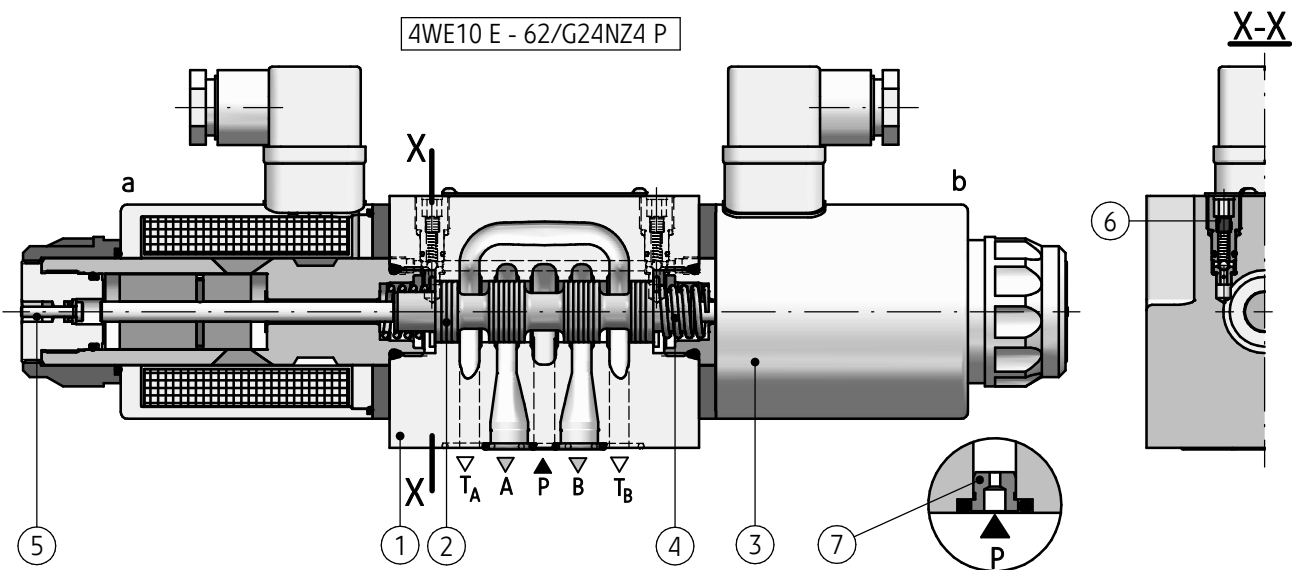

Main elements of directional spool valve type **WE10...P** are: housing (1), solenoids (3), control spool (2), centering springs (4), manual overrides (5) and soft-shift throttle/check valves (6). The spool (2) is shifted when it is moved into one of end positions by the force of solenoid (3) affecting it. The return of the spool into neutral position and centering are secured by the centering springs (4). The shape of the spool (2) (control edge spacing) causes change of the hydraulic diagram performed by the valve. Functions of ports:

P - supply port

TA, TB - oil return to the tank

A, B - ports for a receiver (a hydraulic cylinder or a hydraulic motor)

The throttle/check valves (6) allow for setting the speed of spool (2) position change, independently, at turning on and turning off the solenoids (3) and in the effect, eliminating dynamic states (pressure peaks and flow peaks), causing overload of the receiver and the hydraulic system, as well as noise generation. In case of power failure, the shift of the spool (2) can be done manually by the button (5). The valve can be equipped with a throttling orifice (7), standard mounted in the **P** port.

NOTE:

Prior to start of the operation of the valve, it is necessary to thoroughly vent the soft shift valves (6) ports and solenoid chambers (5) - see page 2: requirements for installation and operation - point 8.

TECHNICAL DATA

Hydraulic fluid	mineral oil					
Required fluid cleanliness class	ISO 4406 class 20/18/15					
Nominal fluid viscosity	37 mm ² /s at temperature 55 °C					
Viscosity range	2,8 up to 380 mm ² /s					
Fluid temperature range (in a tank)	recommended	40°C up to 55°C				
	max	-20°C up to +70°C				
Ambient temperature range	- 20°C up to +50°C					
Maximum operating pressure	ports P, A, B	35 MPa				
	port T	21 MPa				
Switching time	ON	up to 60 ms				
	OFF	up to 40 ms				
Maximum switching frequency	15000 on/h					
Weight	with 1 solenoid	4,6 kg				
	with 2 solenoids	6,2 kg				
Supply voltage of solenoids	DC			AC (plug-in connector with rectifier)		
	12V	24V	110V	230V - 50Hz	220V - 50Hz	110V - 50Hz
Supply voltage tolerance	±10%					
Power requirement (DC)	30 W					
Degree of protection	IP 65					
Solenoid coil temperature	max 150 °C					

INSTALLATION AND OPERATION REQUIREMENTS

- Only fully functional and operational valve, properly connected to electrical installation must be used. Connecting or disconnecting the valve to an electrical installation must only be carried out by qualified personnel.
- Ground connection ($\frac{1}{\text{V}}$) must be connected with protective earth wire (PE $\frac{1}{\text{V}}$) in supply system according to appropriate instructions.
- Solenoid plug shall precisely adhere to socket and shall be secured with thread bolt screwed in securely in a place. It is forbidden to operate the valve if the tightness and suitable clamp of cable in the plug gland are not ensured.
- During the period of operation must be kept fluid viscosity acc. to requirements defined in this Data Sheet - Operation Manual
- In order to ensure failure free and safe operation the following must be checked:
 - condition of the electrical connection
 - proper working of the valve
 - cleanliness of the hydraulic fluid
- Due to heating of electromagnet solenoid coils to high temp., the valve shall be placed in such way to eliminate the risk of accidental contact with solenoid or valve housing during operation or to apply suitable covers acc. to PN - EN ISO 13732 - 1 and PN - EN 4413
- In order to ensure tightness of the directional valve block, one should take care of dimension of sealing rings, tightening torques and valve operation parameters given in this Data Sheet - Operation Manual
- Prior to first use of the valve, one should vent the soft shift valves. It is recommended to set the valve in such a way that the valve settings were directed "upwards". In order to provide a thorough venting, it is recommended to unscrew the soft shift valves, immerse the ports in oil that is used and override the valve without any load. This process should be repeated until the ports are full, and then, the valves can be screwed. After venting, set the valves' setting to achieve optimal operation of the valve.
- A person that operates the valve must be thoroughly familiar with this Data Sheet - Operation Manual.

DIAGRAMS

Diagrams for 3-position directional spool valves

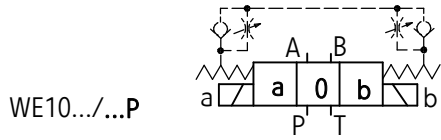

Diagrams for 2-position directional spool valves

versions with positions a, 0

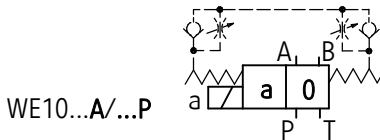

versions with positions 0, b

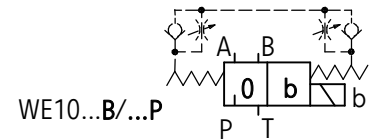

Diagrams for spools

working and indirect positions

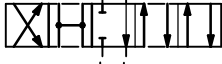
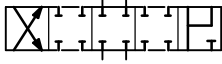
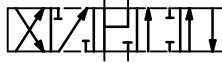
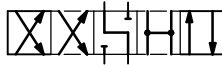
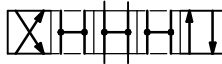
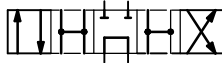
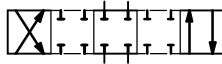
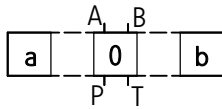

working positions

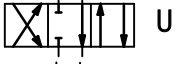
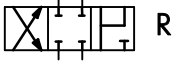
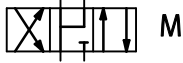
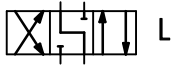
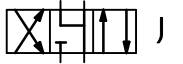
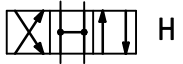
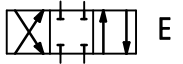
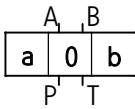

working and indirect positions

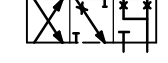
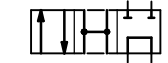
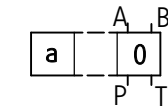

working positions

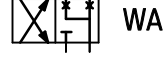
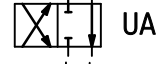
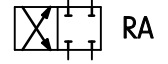
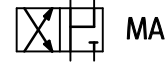
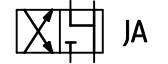
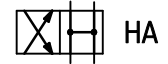
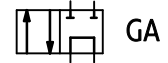
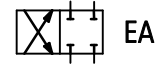
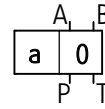

working and indirect positions

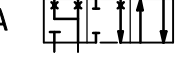
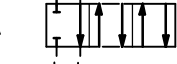
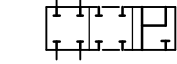
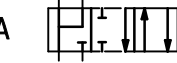
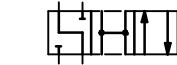
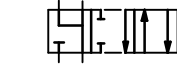
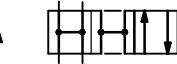
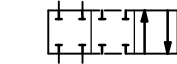
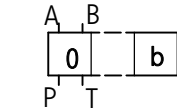

working positions

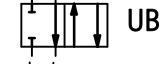
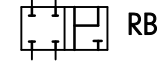
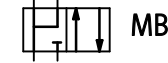
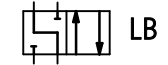
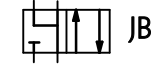
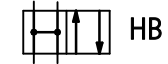
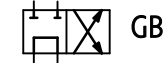
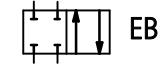
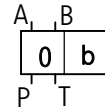

NOTES:

Cross section of flow at middle position performed by the spool **W**; flow direction $A \rightarrow T; B \rightarrow T - 2,5 \text{ mm}^2$

DIAGRAMS

Diagrams for 2-position directional spool valves

versions with positions a, b

WE10.../...P

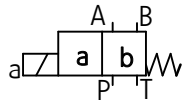

WE10.../...P

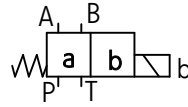

Diagrams for spools working and indirect positions

working positions

working and indirect positions

working positions

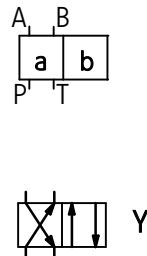
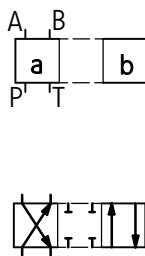
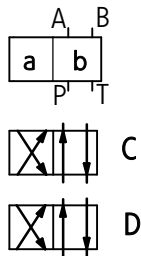
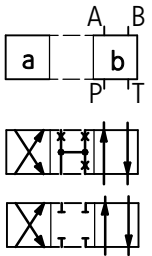
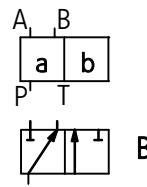
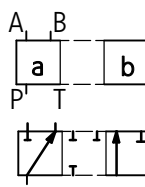
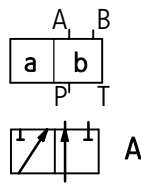
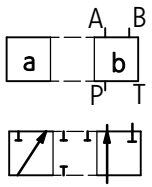

OVERALL AND CONNECTION DIMENSIONS

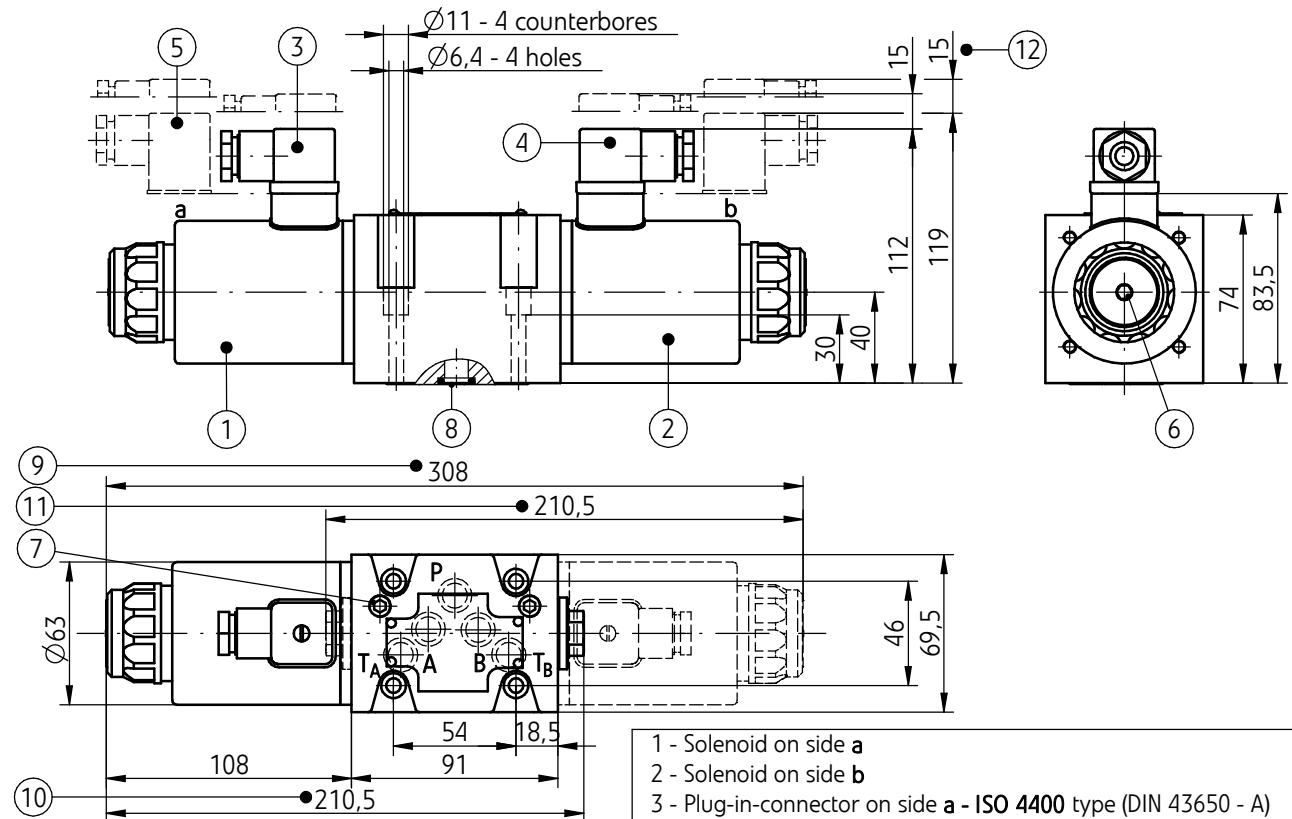

- 1 - Solenoid on side **a**
 - 2 - Solenoid on side **b**
 - 3 - Plug-in-connector on side **a** - ISO 4400 type (DIN 43650 - A)
 - 4 - Plug-in-connector on side **b** - ISO 4400 type (DIN 43650 - A)
 - 5 - Plug-in-connector - ISO 4400 type (DIN 43650 - A) with rectifier
 - 6 - Manual override
 - 7 - Soft-shift valve - setting with hexagonal socket S5 (instructions for setting on page 2)
 - 8 - O-ring 12,42 x 1,78 - 5 pcs/set (P, T_A, T_B, A, B)
 - 9 - Directional spool valve dimension with **2 solenoids** on side **a, b**:
 - **3-position directional spool valve springs centred** (spool diagrams: E, G, H, J, L, M, R, U, W - according to page 3)
 - **2-position directional spool valve without return springs**
 - **2-position directional spool valve without springs and with detent** (spool diagrams: A, C, D - according to page 4)
 - 10 - Directional spool valve dimension with **1 solenoid** - on side **a**
 - **2-position springs positioned** (spool diagrams: A, C, D, EA, GA, HA, JA, LA, MA, RA, UA, WA - according to pages 3, 4)
 - 11 - Directional spool valve dimension with **1 solenoid** - on side **b**
 - **2-position springs positioned** (spool diagrams: B, Y, EB, GB, HB, JB, LB, MB, RB, UB, WB - according to pages 3, 4)
 - 12 - Space required to remove the plug - pos. 3, 4, 5
 - 13 - Porting pattern for directional spool valve - configuration of connection holes in accordance with the standard ISO 4401* - designation ISO 4401-05-04-0-94 (CETOP 05) fixing screws M6 x 40 - 10.9 - in accordance with PN-EN ISO 4762 - 4 pcs/set; must be ordered separately; tightening torque Md = 15 Nm.
- NOTE:**
 (*) - connection with 1 hole T from the side of the hole A or B is enough - holes T and T are connected with the port in the housing of directional spool valve
- 14 - Subplate surface required

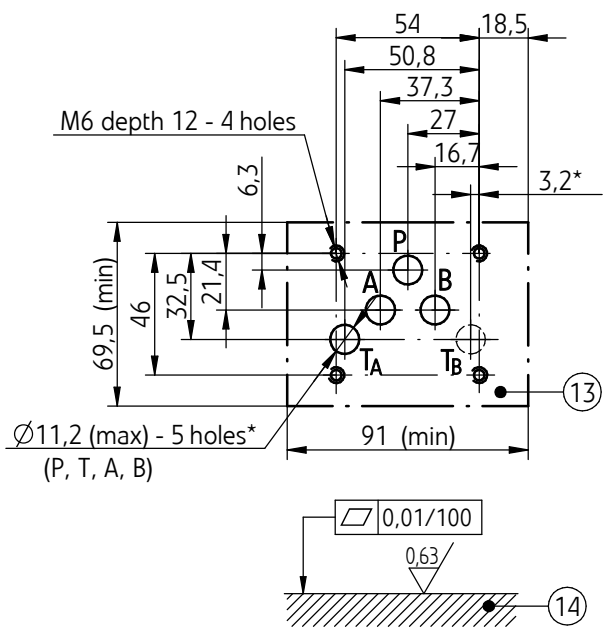

PERFORMANCE CURVES

measured at viscosity $\nu = 41 \text{ mm}^2/\text{s}$ and temperature $t = 50^\circ\text{C}$

Flow resistance curves

characteristic curves $\Delta p(Q)$ for directional spool valve type WE10...P for various spool types

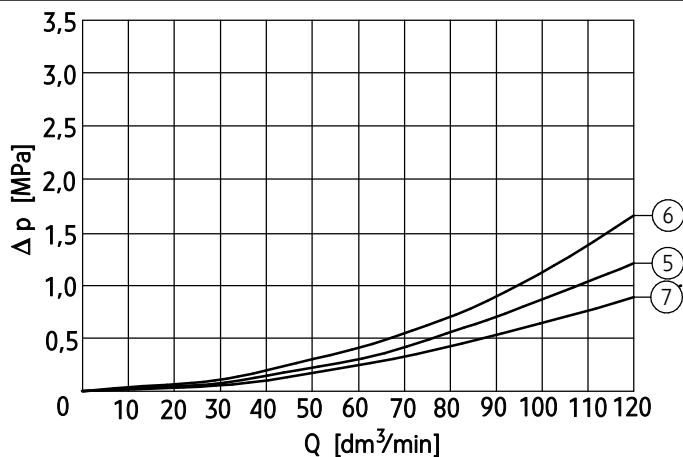

spool symbol diagrams according to pages 4,5	diagram number			
	flow direction			
	P → A	P → B	A → T	B → T
E	2	2	4	4
G	6	6	5	5
H	2	2	1	1
J	2	2	5	5
D	3	3	7	7

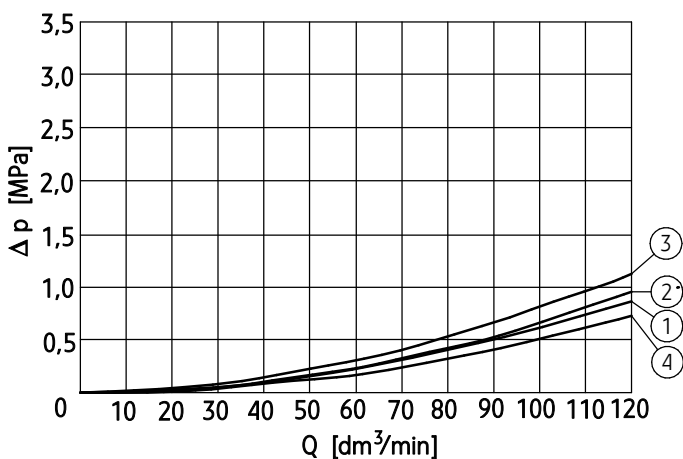

Operating limits curves

characteristic curves $p-Q$ for directional spool valve type WE10...P for various spool types

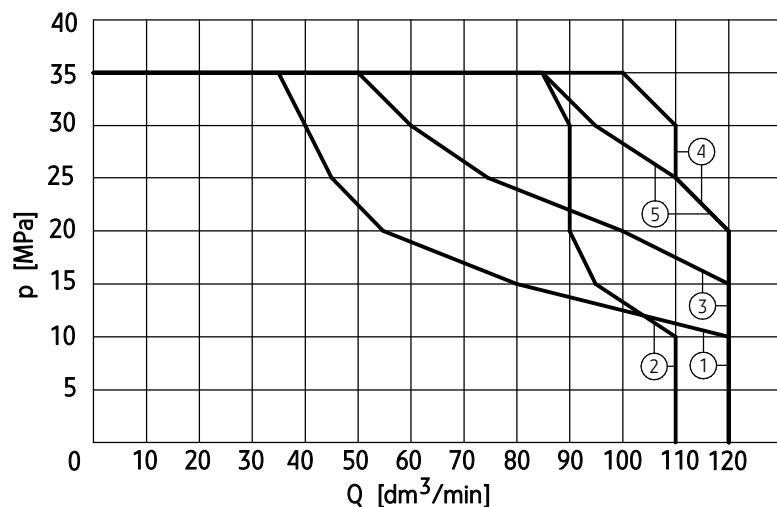

spool symbol diagrams according to pages 4,5	diagram number
E	1
H	2
J	3
G	4
D	5

NOTES:

Above operating limits are related to symmetrical flow through all ports i.e. if the oil flows from port P to port A, then the same flow rate is from port B to port T

(applied to directional control valves with 4 service ports). Degree of asymmetry affects adversely the parameters.

HOW TO ORDER

	WE	10	+	/						P	*
--	-----------	-----------	----------	----------	--	--	--	--	--	----------	----------

Number of service ports

3-way - only for spools A, B = **3**
4-way - for the other spools = **4**

Nominal size (NS)

NS10 = **10**

Spool symbol

spool diagrams - according to page **3, 4**

Series number

(60-69) - connection and installation dimensions unchanged = 6X
series 62 = **62**

Control voltage for solenoids

12V DC = G12
24V DC = **G24**
 110V DC = G110
 110V AC 50Hz (plug-in-connector with rectifier) = W110R
 220V AC 50Hz (plug-in-connector with rectifier) = W220R
230V AC 50Hz (plug-in-connector with rectifier) = **W230R**

Manual override

solenoids with manual override = **N**
 solenoids without manual override = no designation

Electrical connection

plug-in connector type ISO 4400 (DIN 43650 - A) **without LED** = **Z4**
 plug-in connector type ISO 4400 (DIN 43650 - A) with LED = Z4L

Throttle insert (in port P)

without throttle insert = **no designation**
 throttle insert ϕ 0,8 = B 08
 throttle insert ϕ 1,0 = B 10
 throttle insert ϕ 1,2 = B 12
 throttle insert ϕ 3,0 = B 30

Sealing

NBR (for fluids on mineral oil base) = **no designation**
 FKM (for fluids on phosphate ester base) = V

Soft-shift function

valve with soft shift function = **P**

Further requirements in dear text

(to be agreed with the manufacturer)

NOTES:

Directional spool valve should be ordered according to the above coding.

The symbols in bold are preferred versions in short delivery time.

Coding example: 4WE10 E - 62/G24 N Z4 P

SUBPLATES AND FIXING SCREWS

Subplates must be ordered according to data sheet

WK 496 520. Subplate symbols:

G 66/01 - threaded connections G 3/8

G 67/01 - threaded connections **G 1/2**

G 89/01 - threaded connections G 1/4

G 67/02 - threaded connections M22 x 1,5

NOTE:

Subplate symbol in bold is the preferred version available in short delivery time.

Subplates and fixing screws **M6 x 40 - 10,9** - 4 pcs/set according to **PN - EN ISO 4762** must be ordered separately.

Tightening torque **Md = 15 Nm**

EXAMPLE OF APPLICATION IN HYDRAULIC SYSTEM

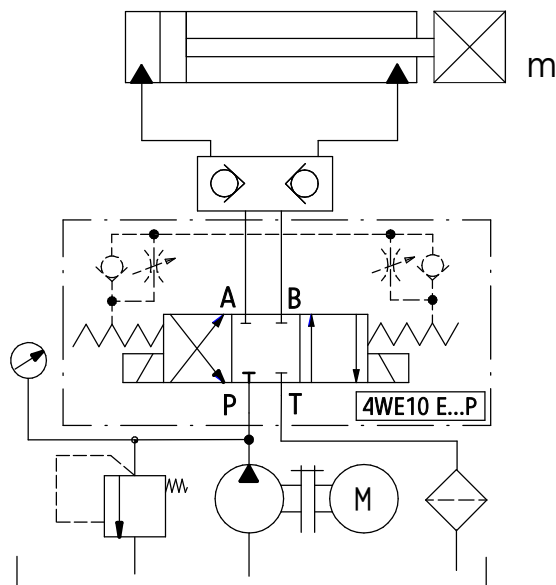

PONAR Wadowice S.A.
ul. Wojska Polskiego 29
34-100 Wadowice
tel. +48 33 488 21 00
fax. +48 33 488 21 03
www.ponar-wadowice.pl

 **PONAR**[®]
wadowice