

DATA SHEET - OPERATION MANUAL

APPLICATION

The 4-way directional control valves type IWE6... electrically operated are intended for change in direction of fluid flow in a hydraulic system. This valve is mainly used in hazardous areas especially in underground pit mines (group I) and in equipment working in vicinity of flammable substances like gas, vapour, fog (group II). It is certified with explosion proof attest:

⊕ I M1 Ex ia I Ma; ⊕ II 2G Ex ia IIC T6/T5 Gb. Can work with outlet explosion proof circuit "ia" or "ib" with maximum parameters $U_i = 15\text{ V}$; $I_i = 1,6\text{ A}$; $C_i = 0$; $L_i = 0$. Temperature classes T5 and T6 are dependent on ambient temperature, according to data table on page 2.

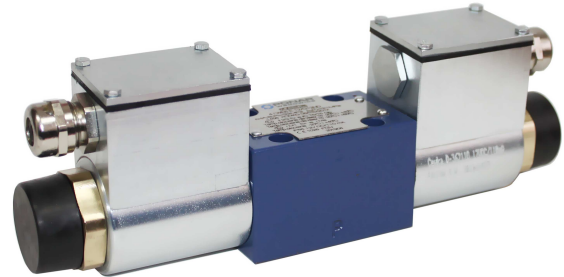

DESCRIPTION OF OPERATION

The directional valve is switched by changing position of the spool (3) which moving along its axis separates or connects ports **A, B, P, T** in the housing (1). The move of the spool is secured by the putting voltage on coil (2) through the terminal strip (10). The return of the spool is realized by the spring (4). An optional manual override button (6) permits movement of the spool without solenoid. The valve is equipped with explosion proof solenoid type EMSGI – 45. Solenoid is assembled with sleeve (5) and manual override button (6).

There is a coil (2) on the sleeve (6). Outside of coil mounted is cable box (7). Inside the cable box (7) are diodes as well as safety device (9) preventing excessive current increase. Electrical connection for is realized by using terminal strip (10) and for type with light signaling applied diode LED (11). The diode is mounted inside cable box (7). Power lead must be sealed and immobilized using gland (12). Sealing rings (14) protect the coil against external impacts and prevent from turn of coil after tightening up the nut (13).

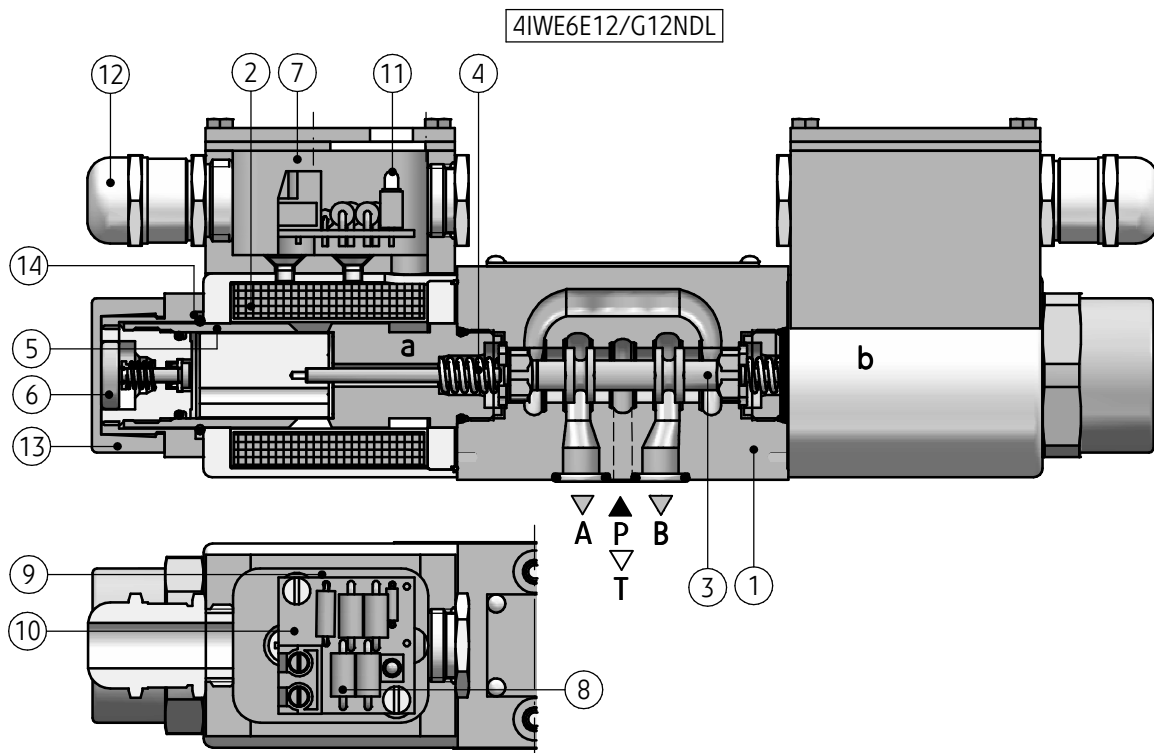

DESCRIPTION OF OPERATION

Directional valve type **IWE6...** can be equipped by throttle insert (15) mounting in port **P** - version ...**IWE6...B...**

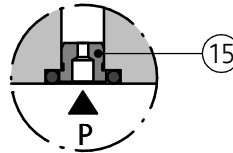

TECHNICAL DATA

Hydraulic fluid	mineral oil	
Required filtration	up to 16 μm	
Recommended filtration	up to 10 μm	
Nominal fluid viscosity	37 mm ² /s at temperature 55°C	
Viscosity range	2,8 up to 328 mm ² /s	
Fluid temperature range	-20 up to 60 °C	
Optimum fluid temperature range	40 up to 55 °C	
Relative humidity of air	to 95 %	
Protective coating	housing	epoxy chemically resistant enamel
	solenoid	hot galvanizing
Maximum operating pressure	port P, A, B - 31,5 MPa	
	port T - 21 MPa	
Maximum flow	20 dm³/min	
Weight	1,6 kg	
Supply voltage U_n	12 V DC	
Supply current I _n	110 mA	
Degree of protection	IP 65	

ACCORDING TO DIRECTIVE 94/9/WE

Quality certificate	CE 1026 FTZU	No. FTZU 05 ATEX Q 013
Inspection certificate	1456 KOMAG 06ATEX201X	
Type of protect ion Ambient temperature T _a	I M 1 Ex ia I Ma - 20 up to 40 °C	
Type of protect ion Ambient temperature T _a	II 2G Ex ia IIC T6 /T5 Gb for class temperature T6 - 20 up to 40 °C for class temperature T5 - 20 up to 60 °C	

ASSEMBLY AND OPERATION REQUIREMENTS

- Electric connection of the valve must be made according to electric scheme on page 5.
- Conductors of valve must be meet requirements applied in the mining machinery.
- Only skilled workers can direct connect valve to an electrical system.
- The plug must be supported by retains screw.
- During the period of operation must be kept the fluid viscosity and filtration according to requirements defined in Service Manual
- In order to ensure the failure free and safe operation must be check:
 - condition of the electrical connection
 - the verity proper working of the valve
 - cleanness of the hydraulic fluid
- Any valve repair in the mine condition is forbidden. A damaged valve must be supplied to the producer in order to repair. The address of service is shown on the last page of this Data sheet – Service Manual
- A person that operates the valve has to acquaint with Service Manual.

OVERALL AND CONNECTION DIMENSIONS

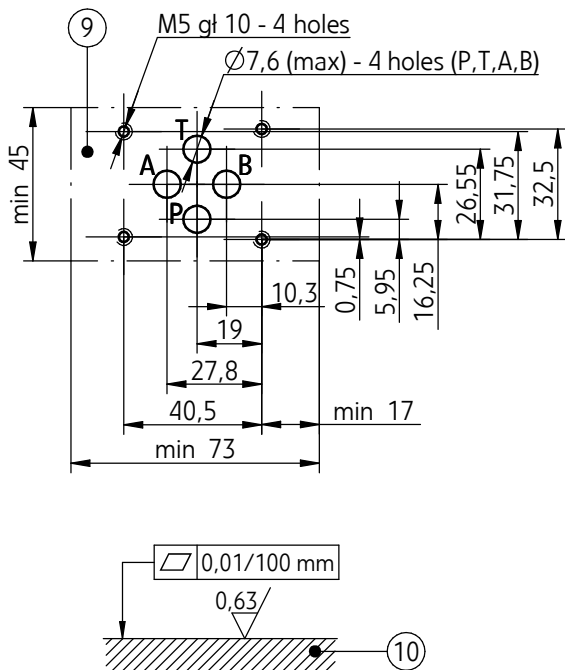
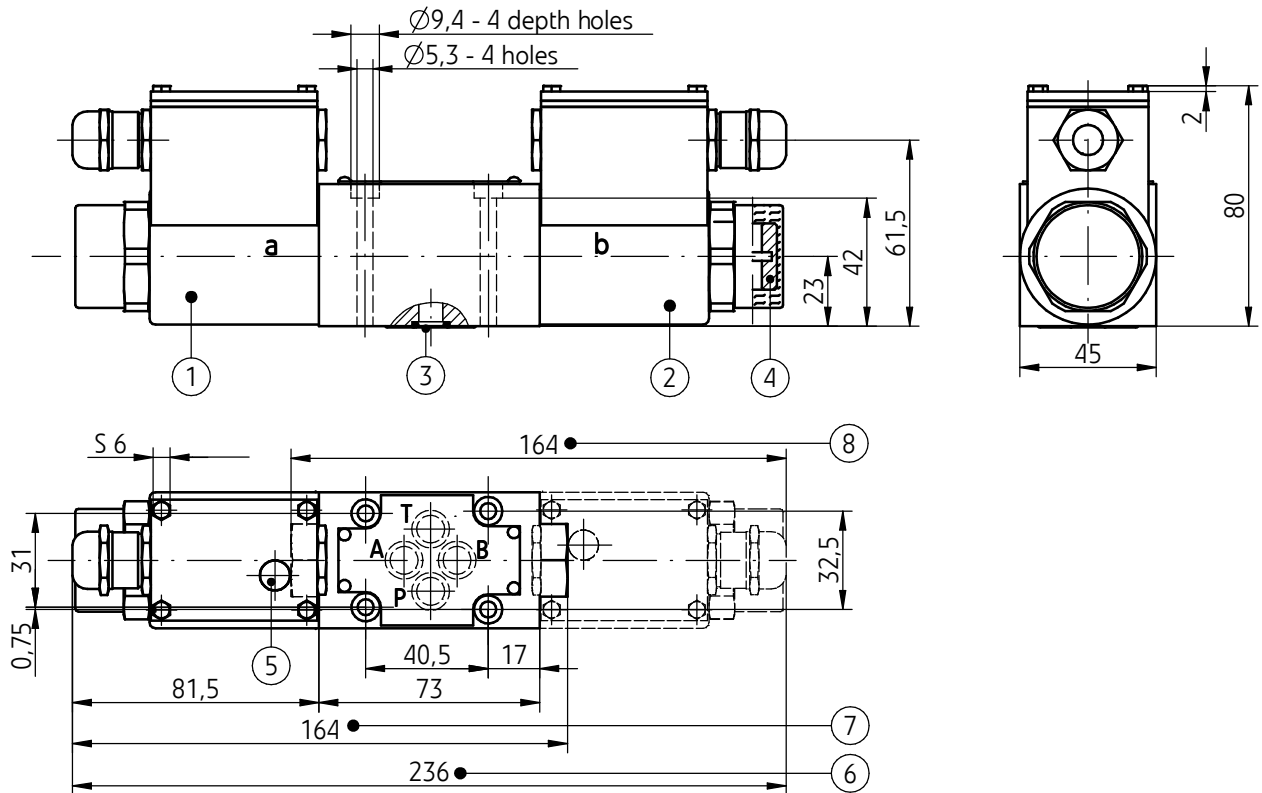

- 1 - Solenoid **a**
- 2 - Solenoid **b**
- 3 - Sealing ring - **o-ring 9,2 x 1,8** - 4 pcs/kit
- 4 - Manual override
- 5 - Diode LED - light signaling
(only version IWE6...DL...)
- 6 - Valve dimension:
3 - position directional valve with return springs
 (solenoids **a** and **b**, spool symbols: **E, H, J, L, M, U** according to page 4)
2 - position directional valve without return springs
 (solenoids **a** and **b** spool symbols: **A, C, D** according to page 4)
- 7 - Valve dimension:
2 - position directional valve with return spring
 (solenoid **a**, spool symbols: **A, C, D, EA, HA, JA, LA, MA, UA** according to page 4)
- 8 - Valve dimension:
2 - position directional valve with return spring
 (solenoid **b**, spool symbols: **B, Y, EB, HB, JB, LB, MB, UB** according to page 4)
- 9 - Porting pattern for directional spool valve configuration of connection holes in accordance with the following standards:
 - **CETOP RP 121H** - identified by CETOP 4.2-4-03 (nominal size **CETOP 03**)
 - **ISO 4401** - identified by ISO 4401-03-02-0-94
 mounting bolts **M5 x 50 - 10.9** in accordance with **PN - EN ISO 4762** - 4 pcs/kit, tightening torque **Md = 9 Nm**
- 10 - Subplate surface required

SCHEMES

Graphic symbols for 3-position directional spool valves

IWE6...1X/...

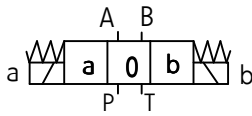

Graphic symbols for 2-position directional spool valves

IWE6..A...1X/...

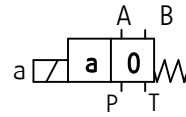

IWE6...B...1X/...

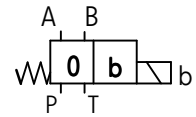

Graphic symbols for spools

working and indirect positions

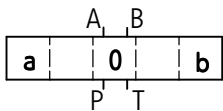

working positions

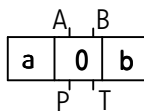

working and indirect positions

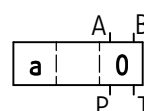

working positions

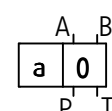

working and indirect positions

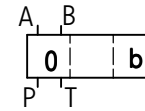

working positions

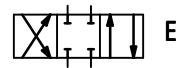
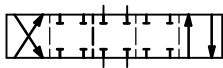
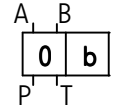

E

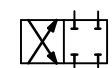

EA

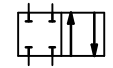
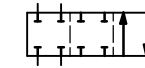

EB

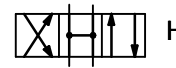
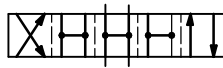

H



HA

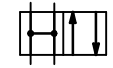
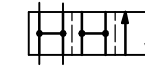

HB

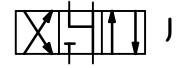

J

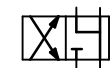

JA

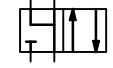
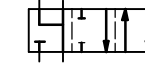

JB

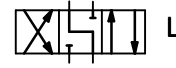

L

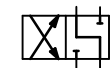

LA

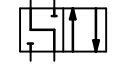
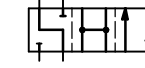

LB

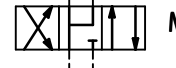
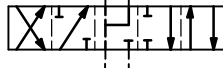

M



MA

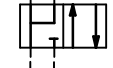
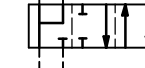

MB

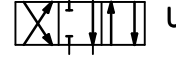
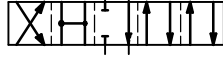

U

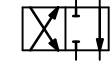

UA

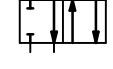

UB

Graphic symbols for 2-position directional spool valves

...IWE6...1X/...

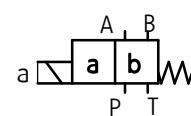
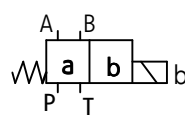
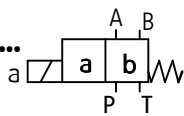

...IWE6..1X/O...

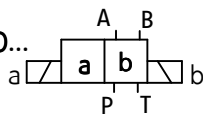

Graphic symbols for spools

working and indirect positions

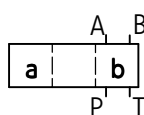

working positions

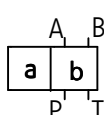

working and indirect positions

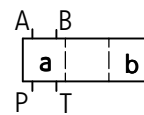

working positions

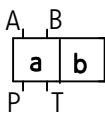

położenia robocze i pośrednie

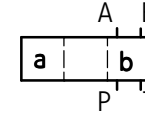

położenia robocze

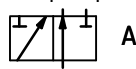
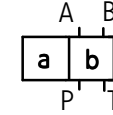

A

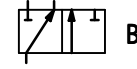
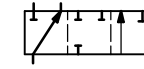

B

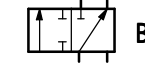
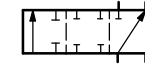

BX

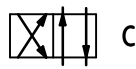

C



D

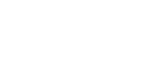

Y

SCHEMES

Electrical scheme of directional control valve

version with cable box without LED
IWE6...D...

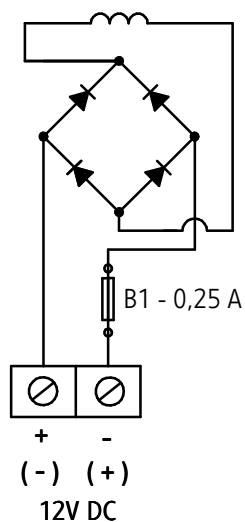

version with cable box and light signaling LED
IWE6...DL...

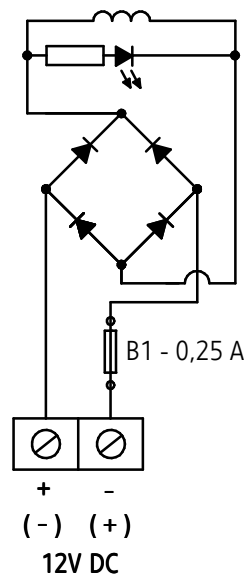

View of electrical connections

versions with cable box
IWE6...D...; IWE6...DL...

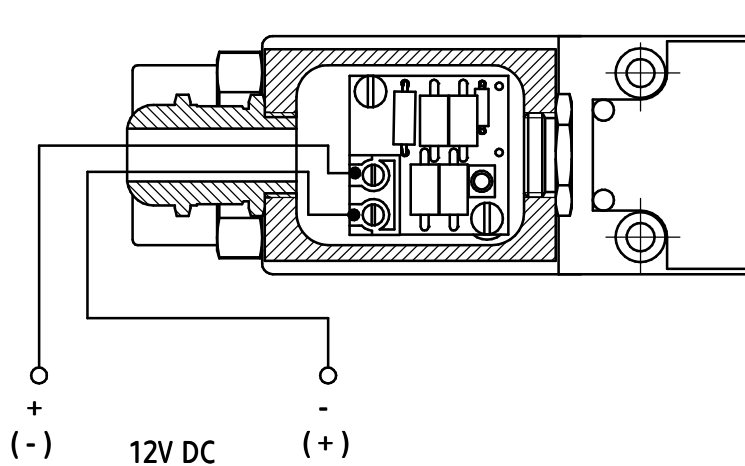

PERFORMANCE CURVES

For fluid viscosity $\nu = 41 \text{ mm}^2/\text{s}$ and temperature $t = 50^\circ\text{C}$

Flow resistance

flow direction: P → A; P → B; A → B; A → T

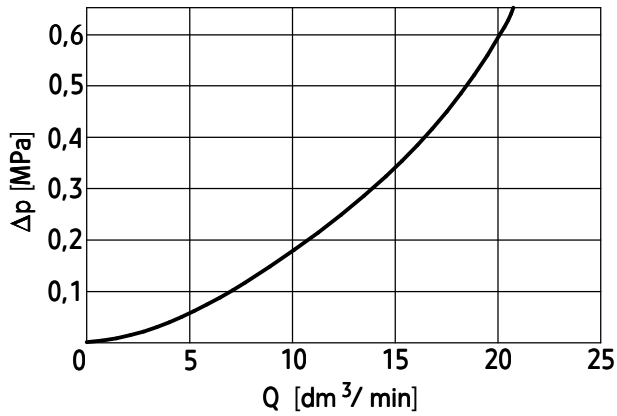

Flow limits

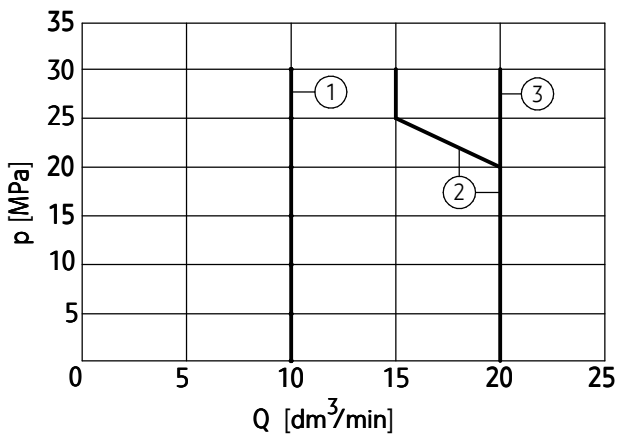

Spool type schemes according to page 4	Performance diagram number
E, A, B	1
A/O	2
H, M, C/O, D/O	3
C, D, J, Y	4
L, U	5

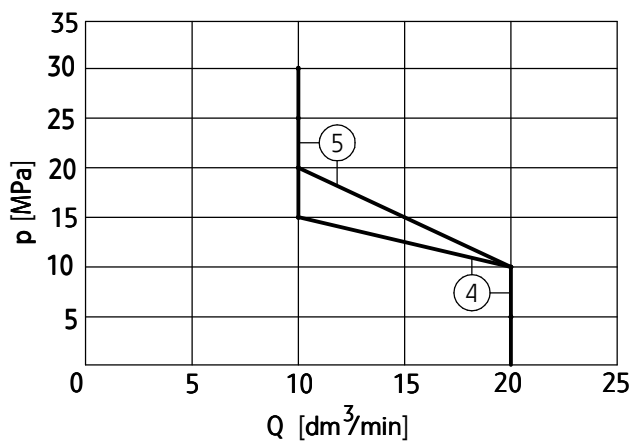

NOTES:

The flow limits refer to typical application of 4-way directional control valve i.e. with using 2 lines e.g. P to A and B to T at the same time. In case of using

4-way directional valve with line e.g. P to A (B plugged) or A to T (B plugged) actual flow limits are considerably lower.

HOW TO ORDER

	IWE	6		12 /		N			
--	------------	----------	--	-------------	--	----------	--	--	--

Number of service ports	
3-way - for spools A, B	= 3
4-way - for the other spools	= 4

Nominal size (NS)	
NS6	= 6

Spool type	
spool symbol	- according to page 4

Series number	= 1X
(10-19) - installation and connection dimensions unchanged	= 12

Spool centering/positioning	
spring centering	= no designation
without reverse spring	= 0

Voltage for solenoids	
DC voltage 12V DC	= G12

Manual override	
solenoids with manual override button	= N

Electrical connections (schemes according to page 5)	
cable box without LED	= D
cable box with LED	= DL

Throttle insert	
without throttle insert	= no designation
throttle insert Ø 0.8 mm	= B 08
throttle insert Ø 1.0 mm	= B 10
throttle insert Ø 1.2 mm	= B 12

Sealing	
NBR (for fluids on mineral oil base)	= no designation
FKM (for fluids on phosphate ester base)	= V

NOTES:

Orders coded in the way showed above should be forwarded to the manufacturer.

Shorter terms of delivery for valves with parameters in bold are possible.

Coding example: 4IWE6 E 12/G12 N D

EXAMPLE OF APPLICATION IN HYDRAULIC SYSTEM

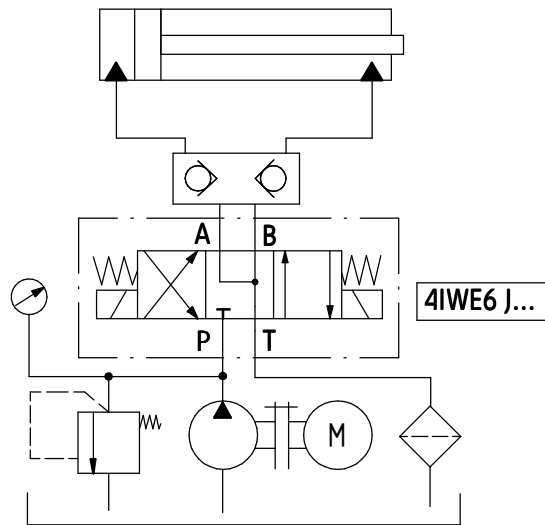

SUBPLATES AND FIXING SCREWS

Subplates must be ordered according to catalogue sheet **WK 496 480**. Subplate symbols:

G 341/01 - threaded connections G 1/4

G 342/01 - threaded connections **G 3/8**

G 502/01 - threaded connections G 1/2

Subplates and bolts fixing directional valve **M5 x 50 - 10,9** in accordance with PN - EN ISO 4762 - 4 pcs/kit must be ordered separately.

NOTE:

Subplate symbol in bold is the preferred version available in short delivery time.

Special execution type ...IWE6...SO495

**APPLICATION, DESCRIPTION OF OPERATION,
ASSEMBLY AND OPERATION REQUIREMENTS,
PERFORMANCE CURVES, SCHEMES,
CONNECTION DIMENSIONS, SUBPLATES,
MOUNTING BOLTS,**

as in basic execution of directional control valve
according to pages 1 - 6

DESCRIPTION OF OPERATION

Directional control valves type ...IWE6...SO495 are equipped with set of latch spring mounted on solenoids. Latch spring (16) centrally mounted forces valve presetting without necessity of manual pressing on button (4). The button is unlocked after latch spring release (16) and return the set to initial position.

NOTES :

Before start-up the position of latch springs of manual control to be checked.

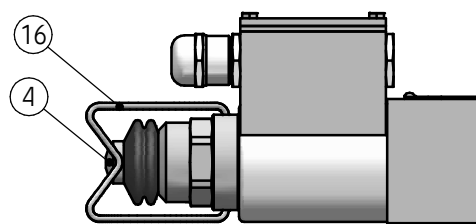

button of manual control
in initial position (unlocked)

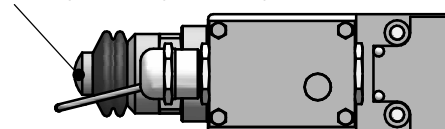

button of manual control locked

TECHNICAL DATA

Hydraulic fluid	mineral oil	
Required filtration	up to 16 μm	
Recommended filtration	up to 10 μm	
Nominal fluid viscosity	37 mm ² /s at temperature 55°C	
Viscosity range	2,8 up to 328 mm ² /s	
Fluid temperature range	-20 up to 60 °C	
Optimum fluid temperature range	40 up to 55 °C	
Relative humidity of air	to 95 %	
Protective coating	housing	epoxy chemically resistant enamel
	solenoid	hot galvanizing
Maximum operating pressure	port P, A, B - 31,5 MPa	
	port T - 10 MPa	
Maximum flow	20 dm³/min	
Weight	1,6 kg	
Supply voltage U_n	12 V DC	
Supply current I _n	110 mA	
Degree of protection	IP 65	

ACCORDING TO DIRECTIVE 94/9/WE

Quality certificate	CE 1026 FTZU	No. FTZU 05 ATEX Q 013
Inspection certificate	1456 KOMAG 06ATEX201X	
Type of protection Ambient temperature T _a	⊕ I M 1 Ex ia I Ma - 20 up to 40 °C	
Type of protection Ambient temperature T _a	⊕ II 2G Ex ia IIC T6 /T5 Gb for class temperature T6 - 20 up to 40 °C for class temperature T5 - 20 up to 60 °C	

Special execution type ...IWE6...SO495

OVERALL AND CONNECTION DIMENSIONS

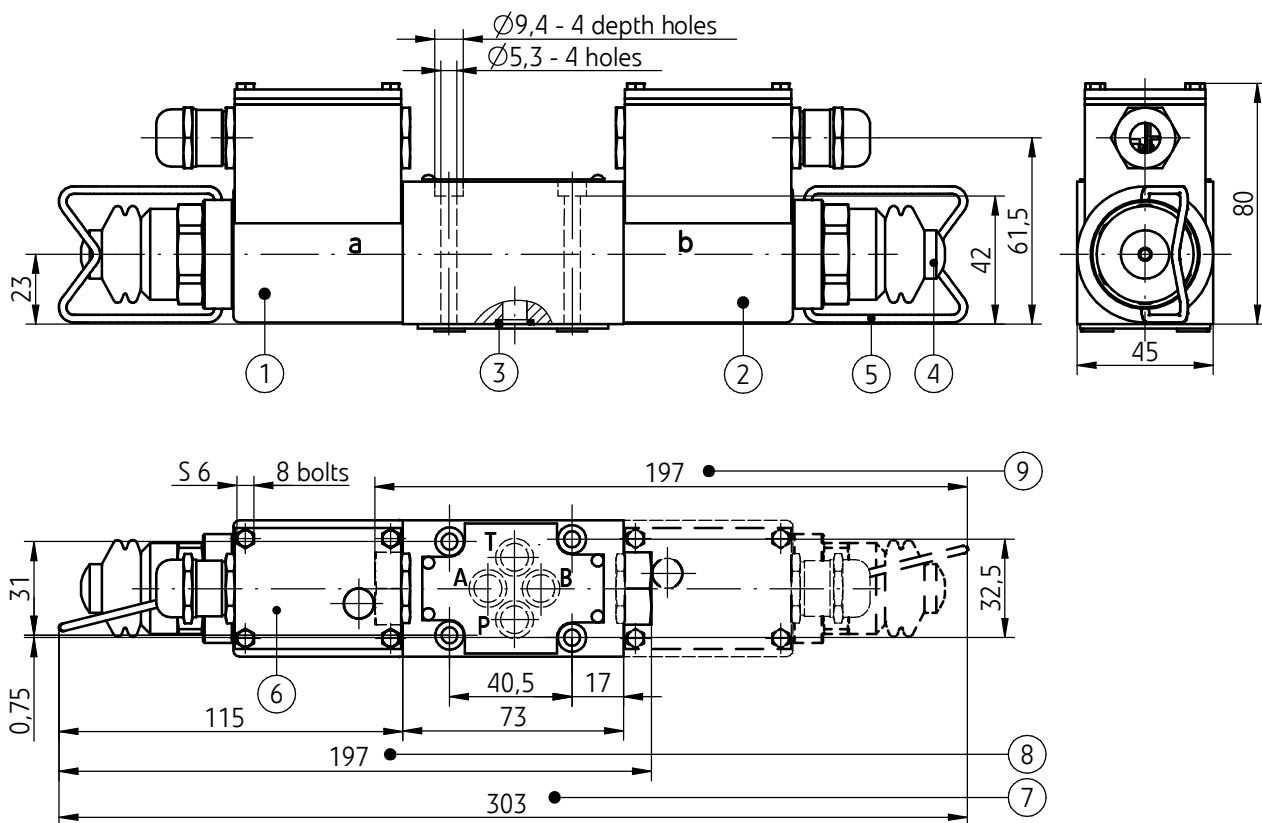

View of connection and required conditions of connecting surface acc. to page 3.

- 1 - Solenoid **a**
- 2 - Solenoid **b**
- 3 - Sealing ring - **o-ring 9,2 x 1,8** - 4 pcs/kit
- 4 - Press button of manual control
- 5 - Lock spring
- 6 - Diode LED - light signal (only type IWE6...DL...)
- 7 - Valve dimension with **2 solenoids - a, b:**
 - **3-position directional valve centered with springs**
(spool symbols: **E, H, J, L, M, U**
according to page 4)
 - **2-position without reverse springs**
(spool symbols: **A, C, D** - according to page 4)
- 8 - Valve dimension with **1 solenoid - a**
 - **2-position set with spring**
(spool symbols: **A, C, D, EA, HA, JA, LA, MA, UA**
according to page 4)
- 9 - Valve dimension with **1 solenoid - b**
 - **2-position set with spring**
(spool symbols: **B, Y, EB, HB, JB, LB, MB, UB**
according to page 4)

HOW TO ORDER

	IWE	6		12 /		N				
--	------------	----------	--	-------------	--	----------	--	--	--	--

Number of service ports
3-way - for spools A, B = **3**
4-way - for the other spools = **4**

Nominal size (NS)
NS6 = **6**

Spool type
spool symbol - according to **page 4**

Series number = **1X**
 (10-19) - installation and connection dimensions unchanged = **12**

Spool centering/positioning
spring centering = **no designation**
 without reverse spring = **0**

Voltage for solenoids
DC voltage 12V DC = **G12**

Manual override
solenoids with manual override button = **N**

Electrical connections (schemes according to page 5)
cable box without LED = **D**
 cable box with LED = **DL**

Throttle insert
without throttle insert = **no designation**
 throttle insert Ø 0.8 mm = **B 08**
 throttle insert Ø 1.0 mm = **B 10**
 throttle insert Ø 1.2 mm = **B 12**

Sealing
NBR (for fluids on mineral oil base) = **no designation**
FKM (for fluids on phosphate ester base) = **V**

Special type
solenoids with latch spring of button manual control = **S0495**

NOTES:

Orders coded in the way showed above should be forwarded to the manufacturer.
Shorter terms of delivery for valves with parameters in bold are possible.
 Coding example: 4 IWE6 E12/G12 N D S0495

PONAR Wadowice S.A.
ul. Wojska Polskiego 29
34-100 Wadowice
tel. +48 33 488 29 00
fax.+48 33 488 21 03
www.ponar-wadowice.pl

